

# SCHLÜSSEL FÜR EINSATZ



Mit Schlitz für Schlüsselring. Auf Anfrage kann der Schlüssel mit dem Logo des Kunden versehen werden.

## Schlüsselform A

Zur Verwendung mit Standard-Drehverschlüssen.

## Schlüsselform B

Zur Verwendung mit Standard- oder Compact-Drehverschlüssen.



### MATERIAL

Schlüssel: Messing

### ÄHNLICHE PRODUKTE

Needed components for a complete system:

2-070

Use the Index Code at [industrilas.com](http://industrilas.com)

### TESTS & STANDARDS

Other colours on request.

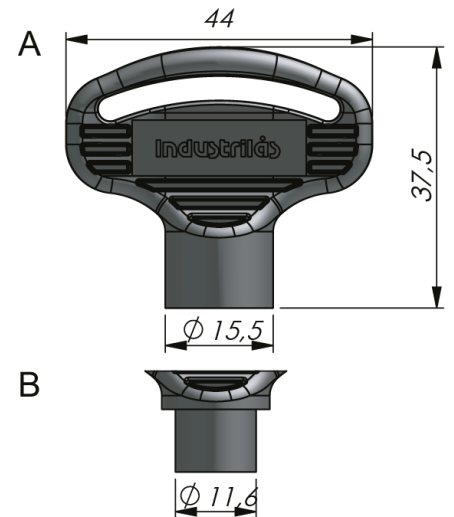
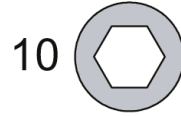
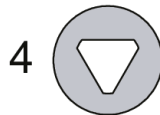
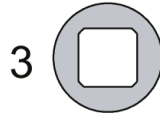
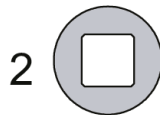
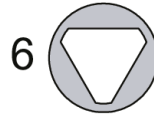
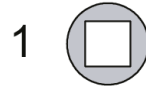

Bestell-Nr.	Betätigung	Ausführung	Abbildung
29501001	Vierkant 6 m. Pfeil	B	1
29501002	Vierkant 7 m. Pfeil	B	2
29501003	Vierkant 8 m. Pfeil	B	3
29501004	Dreikant 6,5	B	13
29501005	Dreikant 7	A	4
29501006	Dreikant 8	A	5
29501007	Dreikant 10	A	6
29501008	Doppelbart 3	A	7
29501009	Doppelbart 5	A	10
29501010	Sechskant 8,5	A	10
29501011	Triangle 10 / radius	A	9
29501012	Innensechskant 8 / 3 mm Dorn	B	11
29501013	Vierkant 8 - versenkt	A	15